

Preliminary Specifications Subject to Change without Notice

DESCRIPTION

The JW[®]5372 and JW[®]5372F are monolithic buck switching regulators based on I2 architecture for fast transient response. Operating with an input range of 4.5V~18V, JW5372 and JW5372F deliver 4A of continuous output current with two integrated N-Channel MOSFETs. The internal synchronous power switches provide high efficiency without the use of an external Schottky diode. At light loads, JW5372 operates in low frequency to maintain high efficiency.

JW5372 and JW5372F guarantee robustness with output short protection, thermal protection, current run-away protection and input under voltage lockout.

JW5372 and JW5372F are available in TSOT23-6 package, which provide a compact solution with minimal external components.

Company's Logo is Protected, "JW" and "JOULWATT" are Registered Trademarks of JoulWatt technology Inc.

FEATURES

- 4.5V to 18V operating input range
- 4A output current
- Up to 96% efficiency
- PFM mode (JW5372) at light load
- FCC mode (JW5372F) at light load
- 600kHz switching frequency
- Internal soft-start
- Input under voltage lockout
- Current run-away protection
- Output short protection
- Thermal protection
- Available in TSOT23-6 package

APPLICATIONS

- Distributed Power Systems
- Networking Systems
- FPGA, DSP, ASIC Power Supplies
- Green Electronics/ Appliances
- Notebook Computers

TYPICAL APPLICATION

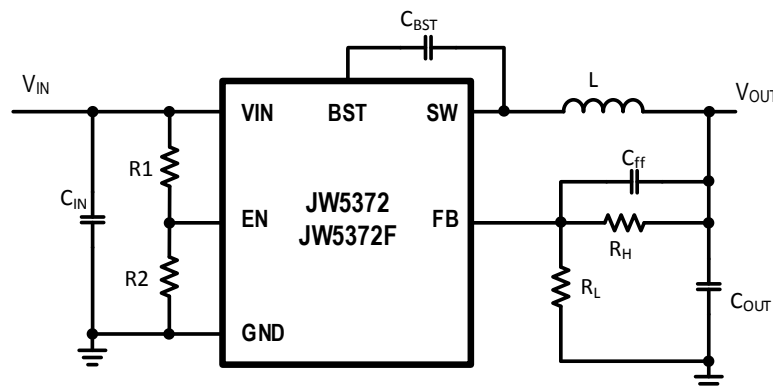

ORDER INFORMATION

DEVICE ¹⁾	PACKAGE	TOP MARKING ²⁾	ENVIRONMENTAL ³⁾
JW5372TSOTB#TR	TSOT23-6	JWRJ□ YW□□□	Green
JW5372FTSOTB#TR	TSOT23-6	JWRK□ YW□□□	Green

Notes:

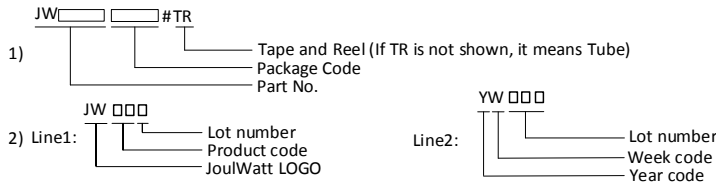

3) All JoulWatt products are packaged with Pb-free and Halogen-free materials and compliant to RoHS standards.

DEVICE INFORMATION

DEVICE	Operation Mode at light load	Package	MSL	STATUS
JW5372TSOTB#TR	PFM	TSOT23-6	MSL1	Available
JW5372FTSOTB#TR	FCCM	TSOT23-6	MSL1	Available

PIN CONFIGURATION

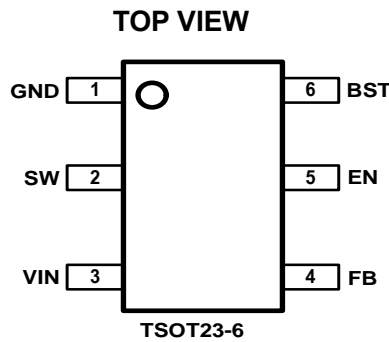

ABSOLUTE MAXIMUM RATING¹⁾

VIN, EN Pin.....	-0.3V to 20V
SW Pin.....	-0.3V(-5V for 10ns) to 20V(22V for 10ns)
BST Pin.....	SW-0.3V to SW+4V
All other Pins	-0.3V to 4V
Junction Temperature ²⁾	150°C
Lead Temperature	260°C
Storage Temperature	-65°C to +150°C
ESD Susceptibility (Human Body Model)	2kV
ESD Susceptibility (Charged Device Model)	500V

RECOMMENDED OPERATING CONDITIONS³⁾

Input Voltage V _{IN}	4.5V to 18V
Output Voltage V _{OUT}	0.765V to V _{IN} *Dmax
Operating Junction Temperature.....	-40°C to +125°C

THERMAL PERFORMANCE⁴⁾

θ_{JA} θ_{JC}

TSOT23-6.....	110.....	55°C/W
---------------	----------	--------

Note:

- 1) Exceeding these ratings may damage the device. These stress ratings do not imply function operation of the device at any other conditions beyond those indicated under RECOMMENDED OPERATING CONDITIONS.
- 2) The JW5372 and JW5372F include thermal protection that is intended to protect the device in overload conditions. Continuous operation over the specified absolute maximum operating junction temperature may damage the device.
- 3) The device is not guaranteed to function outside of its operating conditions.
- 4) Measured on JESD51-7, 4-layer PCB.

ELECTRICAL CHARACTERISTICS

<i>V_{IN}=12V, T_J=25°C, unless otherwise stated.</i>						
Item	Symbol	Conditions	Min.	Typ.	Max.	Unit
V _{IN} Under Voltage Lock-out Threshold	V _{IN_MIN}	V _{IN} rising	4.0	4.2	4.5	V
V _{IN} Under Voltage Lock-out Hysteresis	V _{IN_MIN_HYST}			300		mV
Shutdown Supply Current	I _{SD}	V _{EN} =0V			1	μA
Supply Current	I _Q	V _{EN} =5V, V _{FB} =1.2V		150	220	μA
Feedback Voltage	V _{FB}	4.5≤V _{IN} ≤18V	757	765	773	mV
		T _J =-40 °C~125 °C	750	765	780	mV
FB Leakage Current	I _{FB}	V _{FB} =0.85V			100	nA
Top Switch Resistance	R _{DS(ON)T}			50		mΩ
Bottom Switch Resistance	R _{DS(ON)B}			31		mΩ
Top Switch Leakage Current	I _{LEAK_TOP}	V _{IN} =18V, V _{EN} =0V, V _{SW} =0V			1	μA
Bottom Switch Leakage Current	I _{LEAK_BOT}	V _{IN} =18, V _{EN} =0V, V _{SW} =18V			4	μA
Bottom Switch Current Limit	I _{LIM_BOT}	JW5372	4.0	4.6	5.5	A
		JW5372F	4.4	5.0	6.0	A
Negative Current Limit	I _{LIM_NEG}	JW5372F	-1.2	-1.7	-2.2	A
Minimum On Time ⁵⁾	T _{ON_MIN}			100		ns
Minimum Off Time	T _{OFF_MIN}	V _{FB} =0.4V		170		ns
Maximum On Time	T _{ON_Max}			4		us
EN Rising Threshold	V _{EN_H}	V _{EN} rising	1.1	1.2	1.3	V
EN Falling Threshold	V _{EN_L}	V _{EN} falling	0.98	1.05	1.12	V
Switching Frequency	F _{SW}		480	600	720	kHz
Soft-Start Period ⁵⁾⁶⁾	t _{SS}		1	1.4	2	ms
Thermal Shutdown ⁵⁾	T _{TSD}			160		°C
Thermal Shutdown Hysteresis ⁵⁾	T _{TSD_HYST}			20		°C

Note:

- 5) Guaranteed by design.
- 6) Soft-Start Period is tested from 10% to 90% of the steady state output voltage.

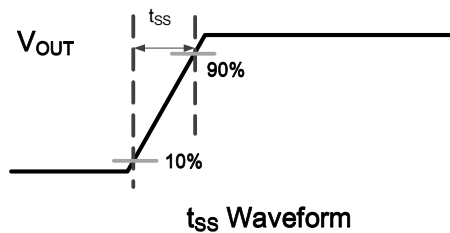

PIN DESCRIPTION

TSOT23-6	Name	Description
1	GND	Ground pin.
2	SW	SW is the switching node that supplies power to the output. Connect the output LC filter from SW to the output load.
3	VIN	Input voltage pin. VIN supplies power to the IC. Connect a 4.5V to 18V supply to VIN and bypass VIN to GND with a suitably large capacitor to eliminate noise on the input to the IC.
4	FB	Output feedback pin. FB senses the output voltage and is regulated by the control loop to 0.765V. Connect a resistive divider at FB.
5	EN	Drive EN pin high to turn on the regulator and low to turn off the regulator.
6	BST	Connect a 0.1μF capacitor between BST and SW pin to supply voltage for the top switch driver.

BLOCK DIAGRAM

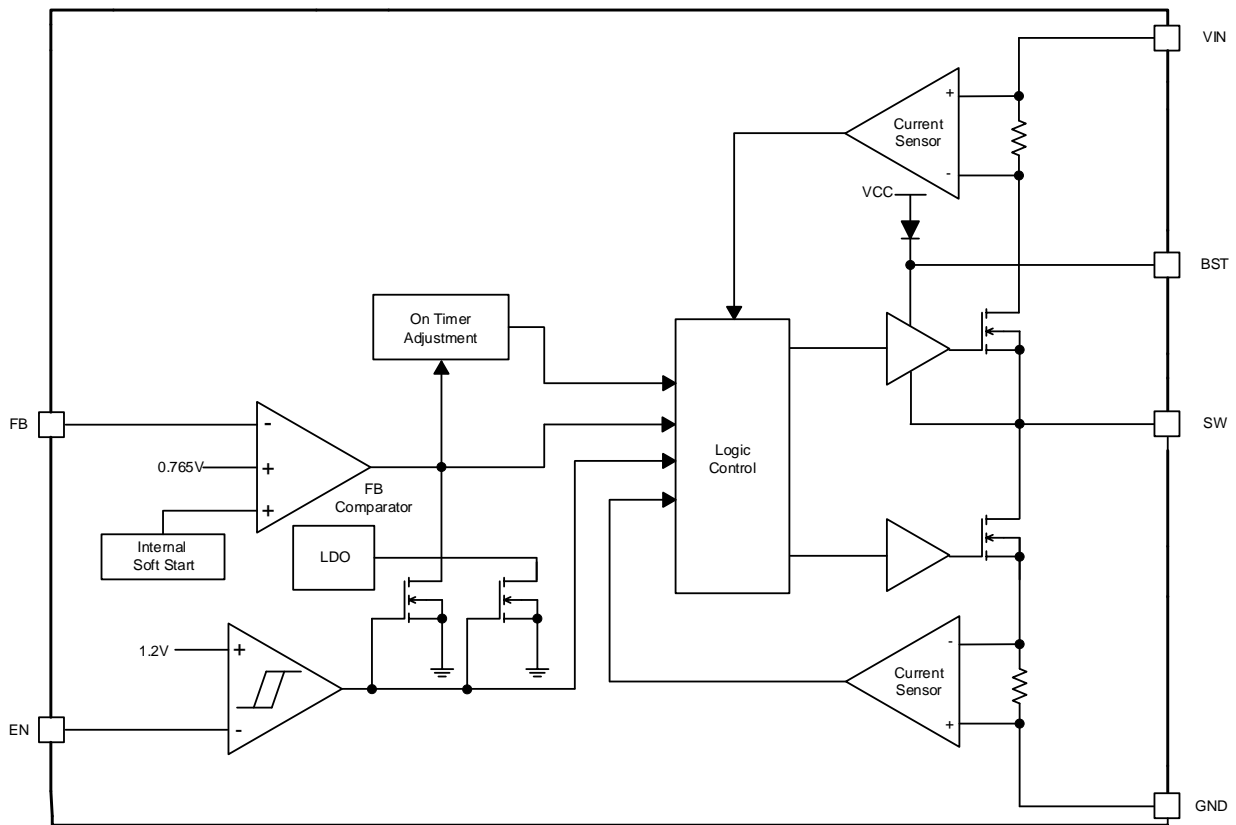

TYPICAL PERFORMANCE CHARACTERISTICS (JW5372)

$V_{IN} = 12V$, $V_{OUT} = 3.3V$, $L = 3.3\mu H$, $C_{OUT} = 22\mu F \times 3$, $T_A = +25^\circ C$, unless otherwise noted

Steady State Test

$V_{IN} = 12V$, $V_{OUT} = 3.3V$
 $I_{OUT} = 4A$

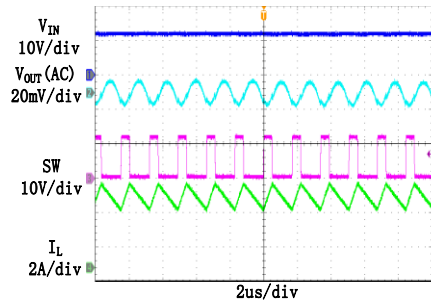

Startup through Enable

$V_{IN} = 12V$, $V_{OUT} = 3.3V$
 $I_{OUT} = 4A$

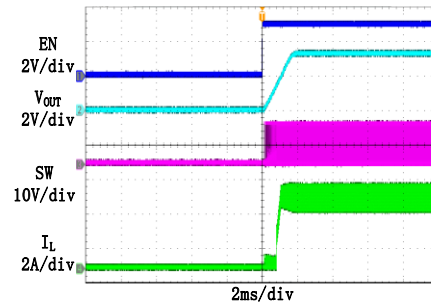

Shutdown through Enable

$V_{IN} = 12V$, $V_{OUT} = 3.3V$
 $I_{OUT} = 4A$

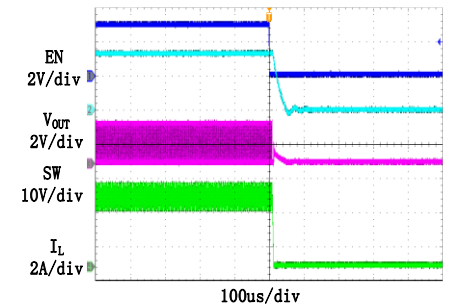

Heavy Load Operation

4A LOAD

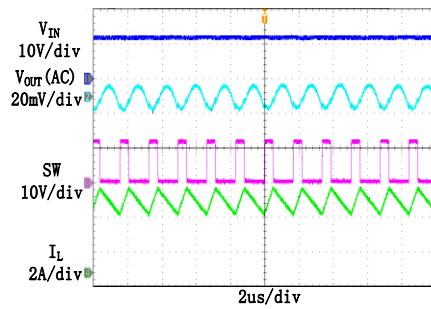

Medium Load Operation

0.4A LOAD

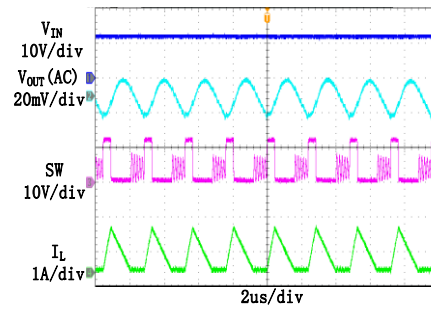

Light Load Operation

0 A LOAD

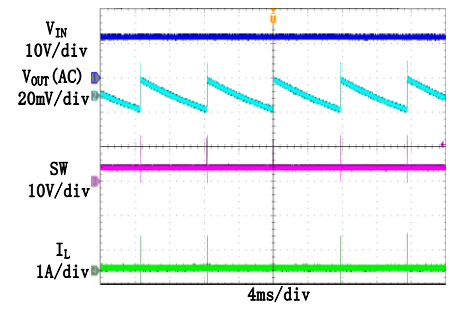

Short Circuit Protection

$V_{IN} = 12V$, $V_{OUT} = 3.3V$
 $I_{OUT} = 4A$ - Short

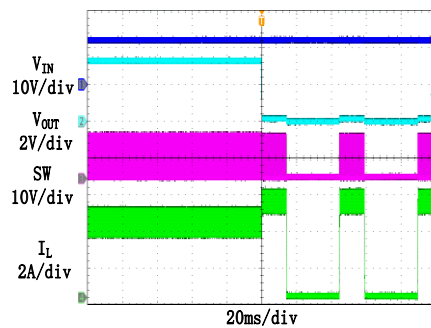

Short Circuit Recovery

$V_{IN} = 12V$, $V_{OUT} = 3.3V$
 $I_{OUT} = \text{Short-4A}$

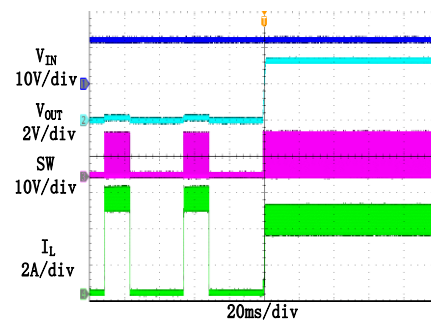

Load Transient

$C_{FF} = 22pF$
4A LOAD \rightarrow 0.4A LOAD \rightarrow 4A LOAD

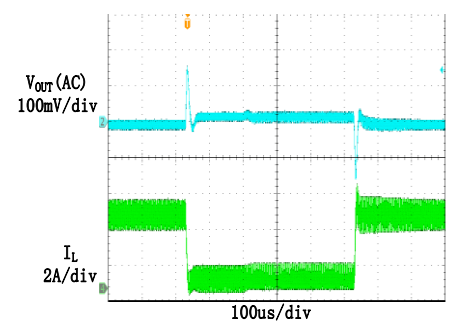

TYPICAL PERFORMANCE CHARACTERISTICS (JW5372F)

$V_{IN} = 12V$, $V_{OUT} = 3.3V$, $L = 3.3\mu H$, $C_{OUT} = 22\mu F \times 3$, $T_A = +25^\circ C$, unless otherwise noted

Steady State Test

$V_{IN} = 12V$, $V_{OUT} = 3.3V$
 $I_{OUT} = 4A$

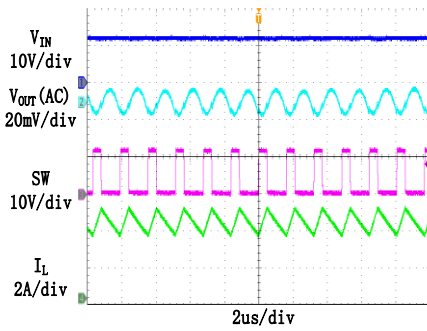

Startup through Enable

$V_{IN} = 12V$, $V_{OUT} = 3.3V$
 $I_{OUT} = 4A$

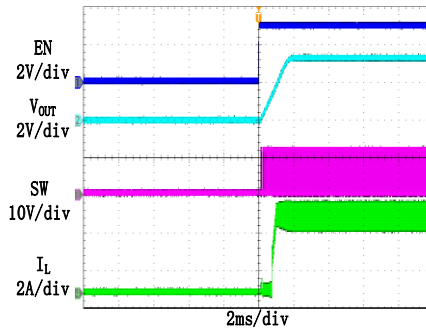

Shutdown through Enable

$V_{IN} = 12V$, $V_{OUT} = 3.3V$
 $I_{OUT} = 4A$

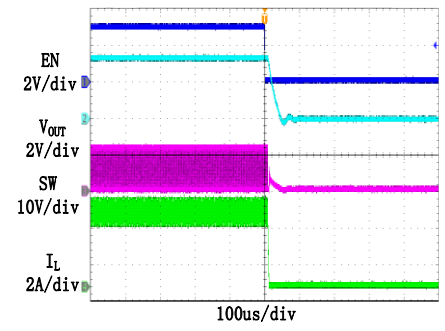

Heavy Load Operation

4A LOAD

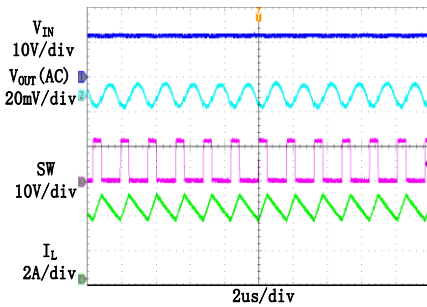

Medium Load Operation

0.4A LOAD

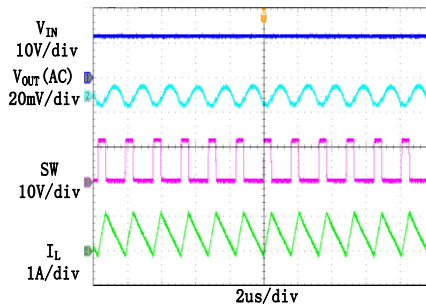

Light Load Operation

0 A LOAD

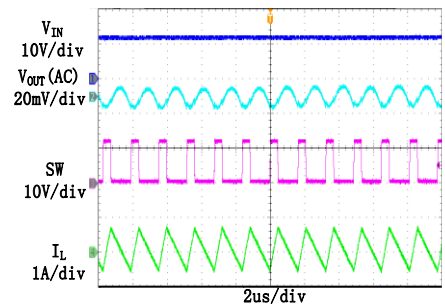

Short Circuit Protection

$V_{IN} = 12V$, $V_{OUT} = 3.3V$
 $I_{OUT} = 4A$ - Short

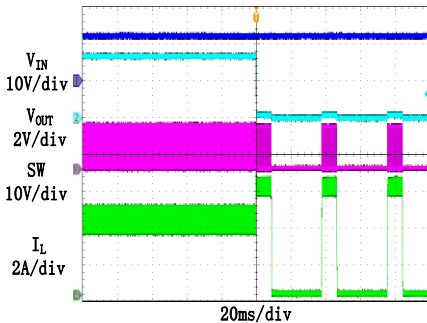

Short Circuit Recovery

$V_{IN} = 12V$, $V_{OUT} = 3.3V$
 $I_{OUT} = \text{Short-4A}$

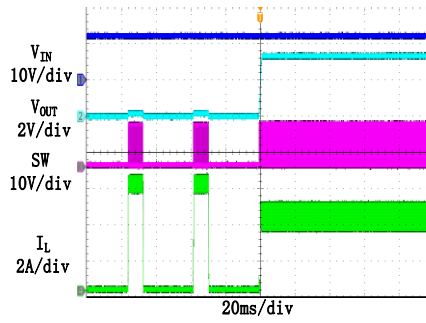

Load Transient

$C_{FF} = 22pF$
4A LOAD \rightarrow 0.4A LOAD \rightarrow 4A LOAD

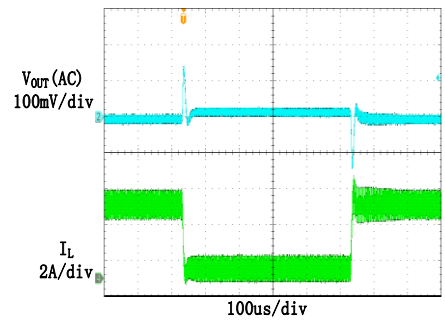

TYPICAL PERFORMANCE CHARACTERISTICS (JW5372)

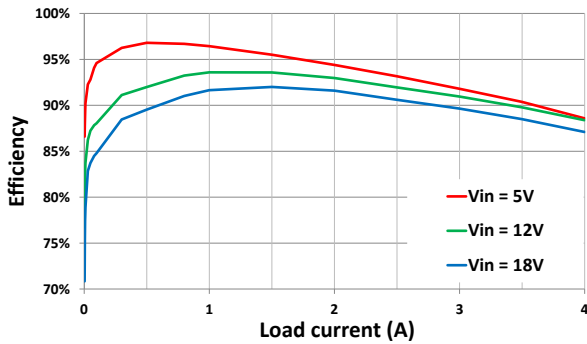

Figure 1. Efficiency vs. Load Current
($V_{OUT}=3.3V$, $L=3.3\mu H$)

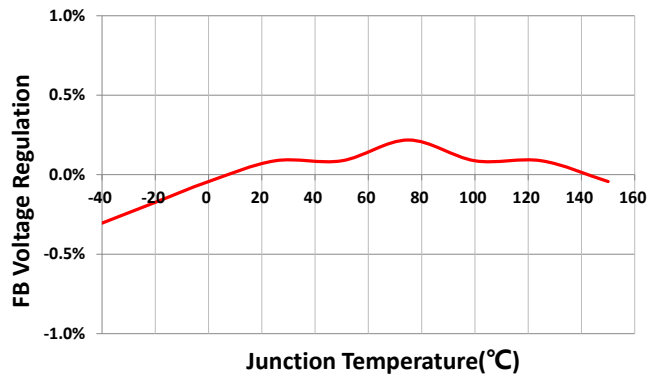

Figure 2. FB Voltage Regulation vs Junction Temperature

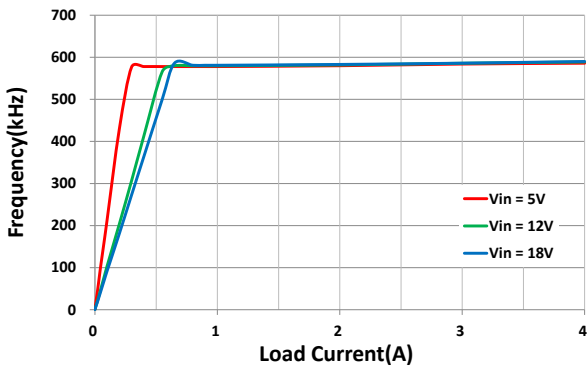

Figure 3. Frequency vs Load Current
($V_{OUT}=3.3V$, $L=3.3\mu H$)

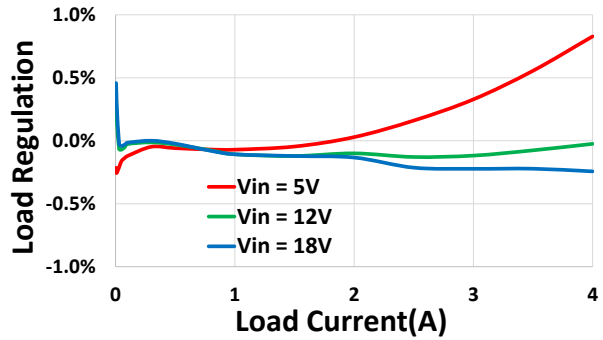

Figure 4. Load Regulation vs Load Current
($V_{OUT}=3.3V$, $L=3.3\mu H$)

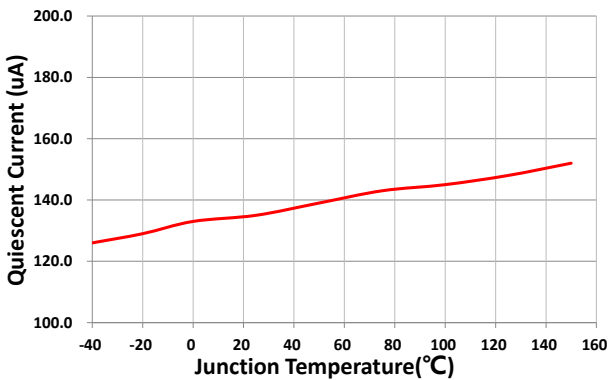

Figure 5. Supply Current vs Junction Temperature

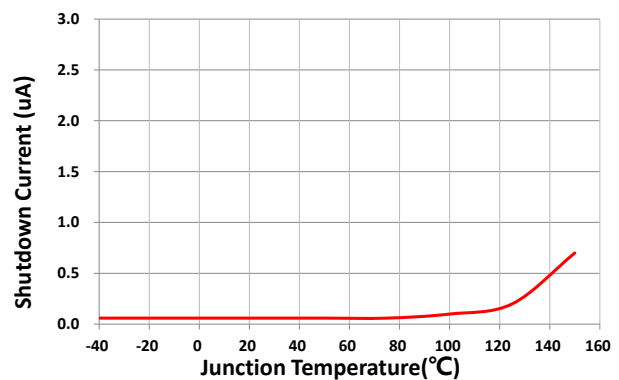

Figure 6. Shutdown Current vs Junction Temperature

TYPICAL PERFORMANCE CHARACTERISTICS (JW5372F)

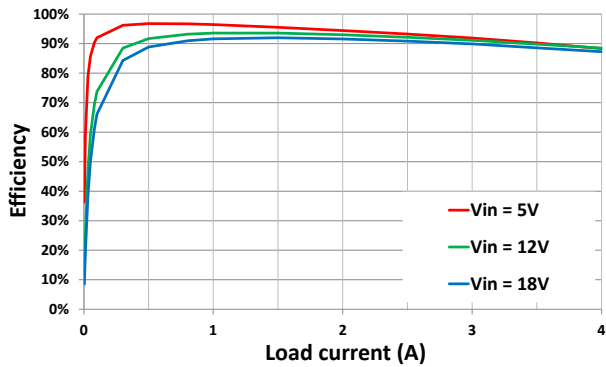

Figure 7. Efficiency vs. Load Current

($V_{OUT}=3.3V$, $L=3.3\mu H$)

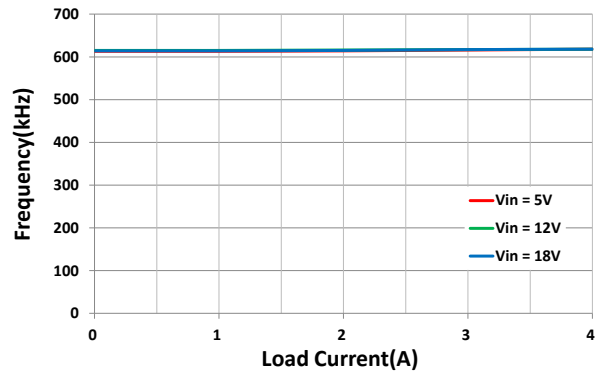

Figure 8. Frequency vs Load Current

($V_{OUT}=3.3V$, $L=3.3\mu H$)

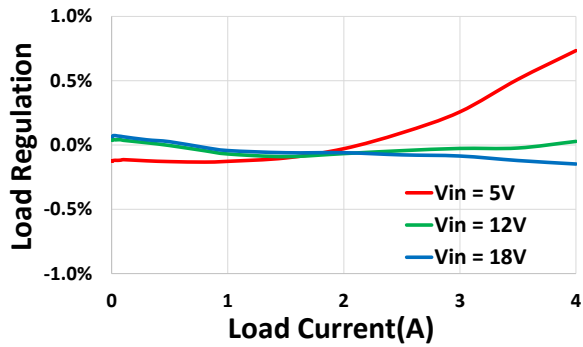

Figure 9. Load Regulation vs Load Current

($V_{OUT}=3.3V$, $L=3.3\mu H$)

FUNCTIONAL DESCRIPTION

JW5372 and JW5372F are synchronous step-down regulators based on I2 control architecture. It regulates input voltages from 4.5V to 18V down to an output voltage as low as 0.765V, and is capable of supplying up to 4A of load current.

Shut-Down Mode

The regulator shuts down when voltage at EN pin is driven below 0.4V. The entire regulator is off and the supply current consumed by the regulator drops below 1 μ A.

Power Switch

N-Channel MOSFET switches are integrated on the JW5372 and JW5372F to down convert the input voltage to the regulated output voltage. Since the top MOSFET needs a gate voltage great than the input voltage, a boost capacitor connected between BST and SW pins is required to drive the gate of the top switch. The boost capacitor is charged by the internal 3.3V rail when SW is low.

V_{IN} Under-Voltage Protection

A resistive divider can be connected between V_{IN} and ground, with the central tap connected to EN, so that when V_{IN} drops to the pre-set value, EN drops below 1.05V to trigger input under voltage lockout protection.

Output Current Run-Away Protection

At start-up, due to the high voltage at input and low voltage at output, current inertia of the output inductor can be easily built up, resulting in a large start-up output current. A valley current limit is designed in JW5372 and JW5372F so that only when output current drops below the valley current limit can the top power switch be turned on. By such control mechanism, the output current at start-up is well controlled.

Output Short Protection

When the output is shorted to ground, the regulator is allowed to switch for 2048 cycles. If the short condition is cleared within this period, then the regulator resumes normal operation. If the short condition is still present after 2048 switching cycles, then no switching is allowed and the regulator enters hiccup mode for 6144 cycles. After the 6144 hiccup cycles, the regulator will try to start-up again. If the short condition still exists after 2048 cycles of switching, the regulator enters hiccup mode. This process of start-up and hiccup iterate itself until the short condition is removed.

Thermal Protection

When the temperature of the regulator rises above 160°C, it is forced into thermal shut-down. Only when core temperature drops below 140°C can the regulator become active again.

APPLICATION INFORMATION

Output Voltage Set

The output voltage is determined by the resistor divider connected at the FB pin, and the voltage ratio is:

$$V_{FB} = V_{OUT} * \frac{R_L}{R_H + R_L}$$

where V_{FB} is the feedback voltage and V_{OUT} is the output voltage.

If R_L is determined, and then R_H can be calculated by:

$$R_H = R_L * \left(\frac{V_{OUT}}{0.765} - 1 \right)$$

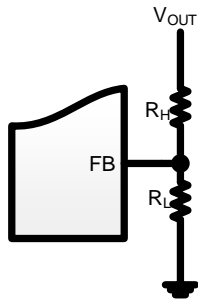

Input Capacitor

The input capacitor is used to supply the AC input current to the step-down converter and maintain the DC input voltage. Estimate the RMS current in the input capacitor with:

$$I_{CIN} = I_{OUT} * \sqrt{\frac{V_{OUT}}{V_{IN}} * \left(1 - \frac{V_{OUT}}{V_{IN}} \right)}$$

where I_{OUT} is the load current, V_{OUT} is the output voltage, V_{IN} is the input voltage.

The input capacitor can be calculated by the following equation when the input ripple voltage is determined.

$$C_{IN} = \frac{I_{OUT}}{f_s * \Delta V_{IN}} * \frac{V_{OUT}}{V_{IN}} * \left(1 - \frac{V_{OUT}}{V_{IN}} \right)$$

where C_{IN} is the input capacitance value, f_s is the switching frequency, ΔV_{IN} is the input ripple voltage.

The input capacitor can be electrolytic, tantalum

or ceramic. To minimizing the potential noise, a small X5R or X7R ceramic capacitor, i.e. 0.1 μ F, should be placed as close to the IC as possible when using electrolytic capacitors.

A 22 μ F/25V ceramic capacitor is recommended in typical application.

Output Capacitor

The output capacitor is required to maintain the DC output voltage, and the capacitance value determines the output ripple voltage. The output voltage ripple can be calculated by:

$$\Delta V_{OUT} = \frac{V_{OUT}}{f_s * L} * \left(1 - \frac{V_{OUT}}{V_{IN}} \right) * \left(R_{ESR} + \frac{1}{8 * f_s * C_{OUT}} \right)$$

where C_{OUT} is the output capacitance value and R_{ESR} is the equivalent series resistance value of the output capacitor.

The output capacitor can be low ESR electrolytic, tantalum or ceramic, which lower ESR capacitors get lower output ripple voltage.

The output capacitors also affect the system stability and transient response, and a 66 μ F ceramic capacitor is recommended in typical application.

Inductor

The inductor is used to supply constant current to the output load, and the value determines the ripple current which affect the efficiency and the output voltage ripple. The ripple current is typically allowed to be 40% of the maximum switch current limit, thus the inductance value can be calculated by:

$$L = \frac{V_{OUT}}{f_s * \Delta I_L} * \left(1 - \frac{V_{OUT}}{V_{IN}} \right)$$

where V_{IN} is the input voltage, V_{OUT} is the output voltage, f_s is the switching frequency, and ΔI_L is the peak-to-peak inductor ripple current.

External Bootstrap Capacitor

The bootstrap capacitor is required to supply voltage to the top switch driver. A 0.1μF low ESR ceramic capacitor is recommended to be connected to the BST pin and SW pin.

PCB Layout Note

For minimum noise problem and best operating performance, the PCB is preferred to following the guidelines as reference.

1. Place the input decoupling capacitor as close to JW5372/JW5372F (VIN pin and GND pin) as possible to eliminate noise at the input pin. The loop area formed by input capacitor and GND must be minimized.
2. Put the feedback trace as short as possible, and far away from the inductor and noisy power traces like SW node.
3. The ground plane on the PCB should be as large as possible for better heat dissipation.
4. Keep the switching node SW short to prevent excessive capacitive coupling
5. Make V_{IN}, V_{OUT} and ground bus connections as wide as possible. This reduces any

voltage drops on the input or output paths of the converter and maximizes efficiency.

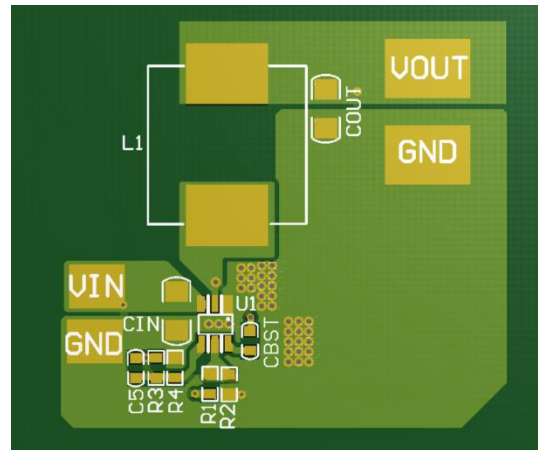

Figure 10. PCB Layout Recommendation

REFERENCE DESIGN

V_{IN} : 4.5V~18V

V_{OUT} : 3.3V

I_{LOAD} : 0~4A

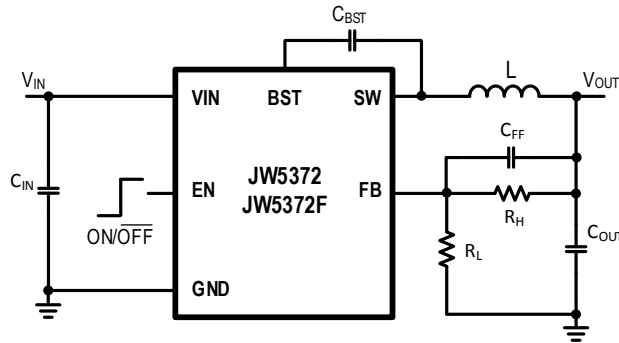

External Components Suggestion ($V_{IN}=12V$):

$V_{OUT}(V)$	$R_L (k\Omega)$	$R_H (k\Omega)$	$C_{FF} (pF)$	$L (\mu H)$	$C_{OUT_MIN} (\mu F)$	$C_{OUT_EFF} (\mu F)$
0.8	16	0.73	47	1.2	66	50
1.2	16	9.1	47	1.5	66	50
1.8	16	21.6	22	2.2	66	40
2.5	16	36.3	22	3.3	66	30
3.3	16	53	22	3.3	66	25
5	9.2	51.1	22	4.7	66	15

Notes:

1. In order to ensure stability, a feedforward capacitor C_{FF} about dozens of picofarads is needed to be in parallel with R_H .
2. Capacitor tolerance and bias voltage de-rating should be considered. The effective capacitance can vary by +20% and -80%. Please refer to the datasheet of capacitor.
3. C_{OUT_MIN} is the minimum nominal capacitance value of C_{OUT} (output capacitance). C_{OUT_EFF} is the minimum effective capacitance value of C_{OUT} (output capacitance).
4. Joulwatt's customers are responsible for determining suitability of components chosen for their purposes. Customers should validate their design implementation to make sure the proper system functionality.

TAPE AND REEL INFORMATION

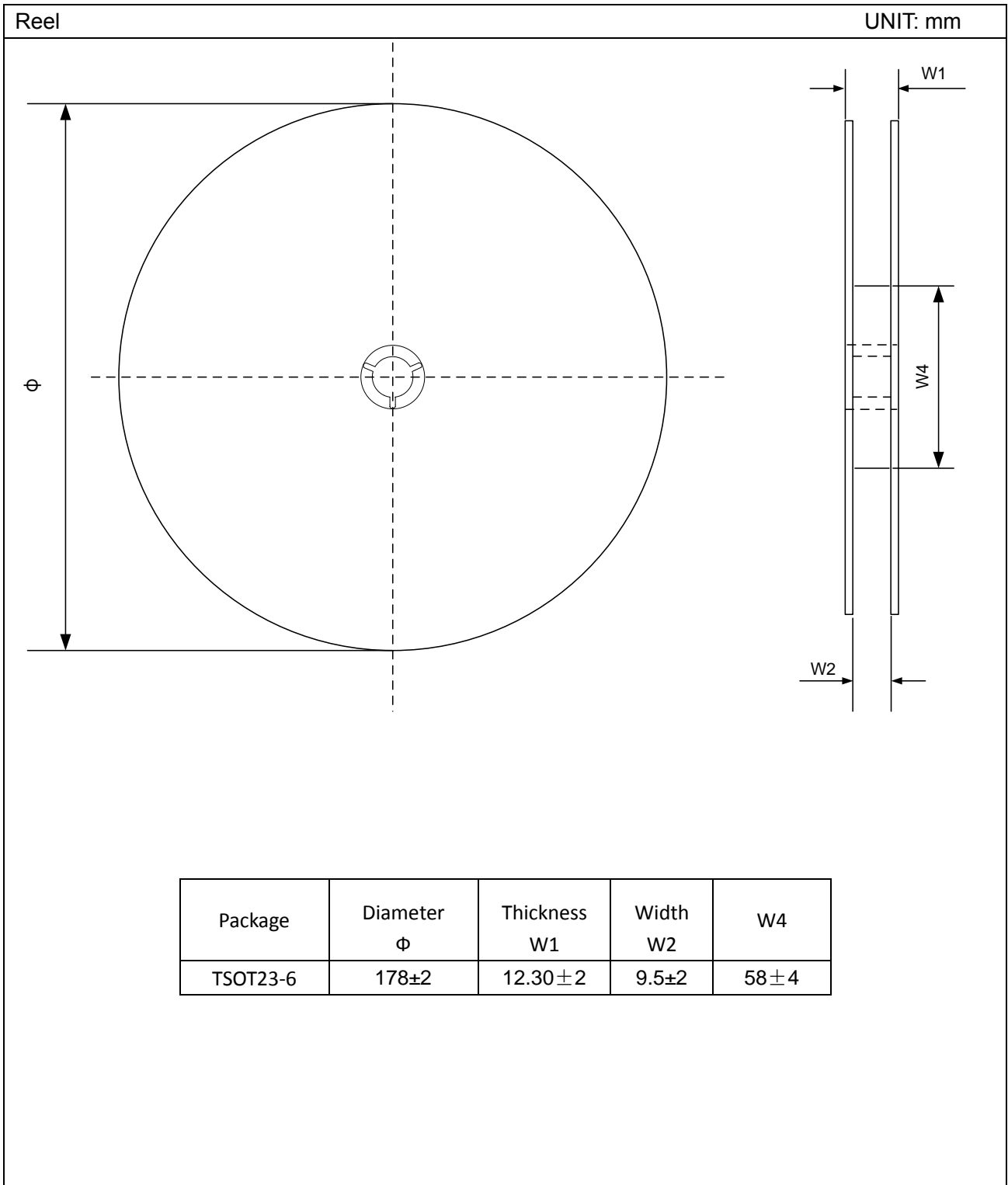

Carrier Tape

UNIT: mm

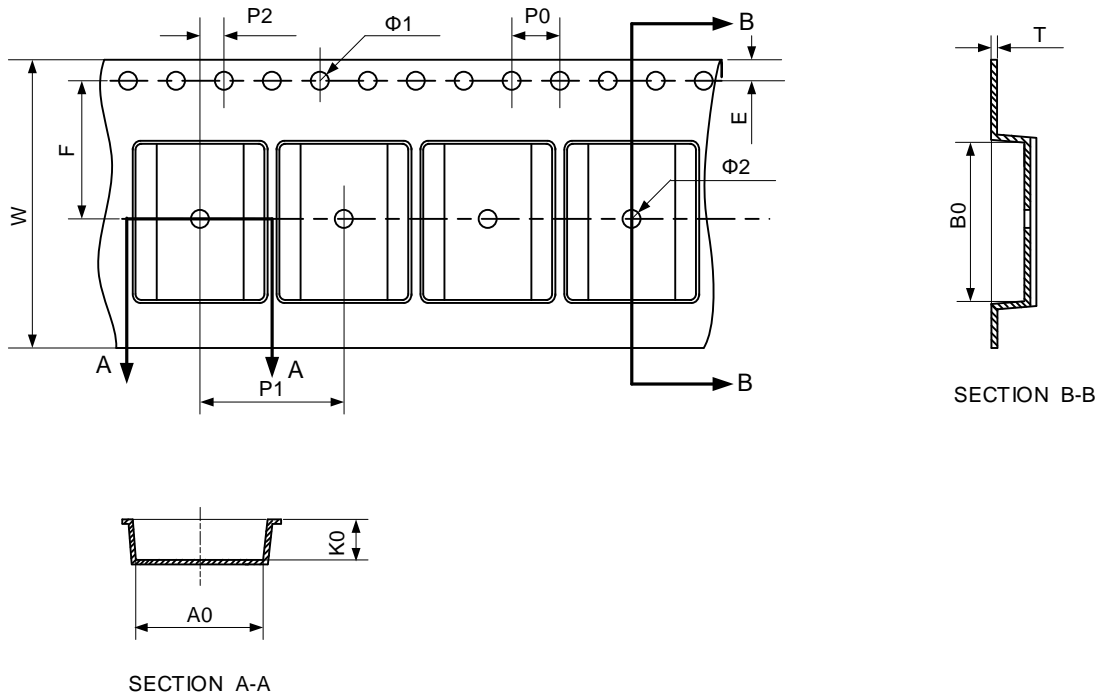

- Note :
- 1) The carrier type is black, and colorless transparent.
 - 2) Carrier camber is within 1mm in 100mm.
 - 3) 10 pocket hole pitch cumulative tolerance:±0.20.
 - 4) All dimensions are in mm.

Package	Tape dimensions(mm)											
	P0	P2	P1	A0	B0	W	T	K0	Φ1	Φ2	E	F
TSOT23-6	4.0±0.1	2.0±0.1	4.0±0.1	3.17±0.20	3.10±0.2	8.0±0.3	0.25±0.2	1.10±0.20	1.50min	1.00min	1.75±0.1	3.50±0.1

PACKAGE OUTLINE

TSOT23-6

UNIT: mm

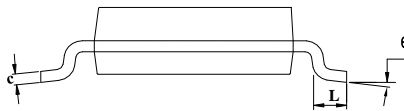
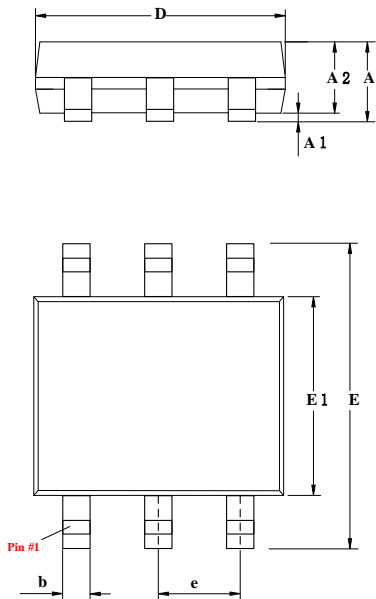

SYMBOL	MILLIMETER		
	MIN	NOM	MAX
A	—	—	1.10
A1	0	—	0.15
A2	0.55	—	1.00
b	0.30	0.40	0.50
c	0.08	0.15	0.30
D	2.70	2.90	3.10
E	2.60	2.80	3.00
E1	1.50	1.60	1.70
e	0.95 (BSC)		
L	0.30	0.45	0.60
θ	0°	—	10°

QUADRANT ASSIGNMENTS FOR PIN 1 ORIENTATION IN TAPE

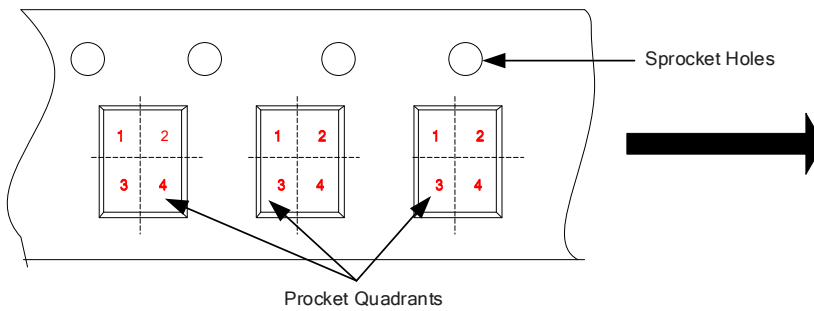

Package Type	Pin1 Quadrant
TSOT23-6	3

IMPORTANT NOTICE

- Joulwatt Technology Inc. reserves the right to make modifications, enhancements, improvements, corrections or other changes without further notice to this document and any product described herein.
- Any unauthorized redistribution or copy of this document for any purpose is strictly forbidden.
- Joulwatt Technology Inc. does not warrant or accept any liability whatsoever in respect of any products purchased through unauthorized sales channel.

Copyright © 2022 JW5372/JW5372F Incorporated.

All rights are reserved by Joulwatt Technology Inc.